



# KISS 1U Short V3

KISS 1U Short V3 CFL

Doc. User Guide, Rev. 1.2

Doc. ID: 1064-5122

This page has been intentionally left blank

 KISS 1U SHORT V3 - USER GUIDE

## Disclaimer

Kontron would like to point out that the information contained in this user guide may be subject to alteration, particularly as a result of the constant upgrading of Kontron products. This document does not entail any guarantee on the part of Kontron with respect to technical processes described in the user guide or any product characteristics set out in the user guide. Kontron assumes no responsibility or liability for the use of the described product(s), conveys no license or title under any patent, copyright or mask work rights to these products and makes no representations or warranties that these products are free from patent, copyright or mask work right infringement unless otherwise specified. Applications that are described in this user guide are for illustration purposes only. Kontron makes no representation or warranty that such application will be suitable for the specified use without further testing or modification. Kontron expressly informs the user that this user guide only contains a general description of processes and instructions which may not be applicable in every individual case. In cases of doubt, please contact Kontron.

This user guide is protected by copyright. All rights are reserved by Kontron. No part of this document may be reproduced, transmitted, transcribed, stored in a retrieval system, or translated into any language or computer language, in any form or by any means (electronic, mechanical, photocopying, recording, or otherwise), without the express written permission of Kontron. Kontron points out that the information contained in this user guide is constantly being updated in line with the technical alterations and improvements made by Kontron to the products and thus this user guide only reflects the technical status of the products by Kontron at the time of publishing.

Brand and product names are trademarks or registered trademarks of their respective owners.

©2019 by Kontron Europe GmbH

Kontron Europe GmbH

Gutenbergstraße 2

85737 Ismaning

Germany

[www.kontron.com](http://www.kontron.com)

## Intended Use

This product, sold by Kontron, is also intended for the use in harsh industrial environments. The product can operate in a temperature range from 0°C to plus 50°C; the storage elements can withstand temperatures from minus 20°C to plus 70°C, and a humidity of 10 to 93 percent does not affect the function of the Product. This makes it particularly suitable for use in industrial automation, process control, high-end image processing and for SCADA/MES applications. This product can be installed in tower, desktop and rackmount environments, as more described in this user manual. You must comply with all product specifications stated in the product documentation and this user manual. If you intend, to incorporate the product into any total systems or applications, please carry out sufficient, compatibility and functions tests prior to any use or resale.

**THIS PRODUCT IS NOT DESIGNED, MANUFACTURED OR INTENDED FOR USE OR RESALE FOR THE OPERATION OF APPLICATION IN A HAZARDOUS ENVIRONMENT, OR REQUIRING FAIL-SAFE PERFORMANCE, OR IN WHICH THE FAILURE OF PRODUCTS COULD LEAD DIRECTLY TO DEATH, PERSONAL INJURY, OR SEVERE PHYSICAL OR ENVIRONMENTAL DAMAGE (COLLECTIVELY "HIGH RISK APPLICATIONS").**

You understand and agree that your use of Kontron products as a component in High Risk Applications is entirely at your own risk. To minimize the risks associated with your systems and applications, you must provide adequate design and operating safeguards. You are responsible to ensure that your systems (and any Kontron hardware or software products incorporated in your systems) meet all applicable requirements. Unless otherwise stated in the product documentation, the Kontron product is not provided with error-tolerance capabilities and therefore cannot be deemed as being engineered, manufactured or setup to be compliant for implementation or for resale as a component in High Risk Applications. All application and safety related information in this document (including application descriptions, suggested safety measures, suggested Kontron products, and other materials) is provided for reference only.

---

**NOTICE**

You find the most recent version of the "General Safety Instructions" online in the download area of this product.

---

---

**NOTICE**

This product is not suited for storage or operation in corrosive environments, in particular under exposure to sulfur and chlorine and their compounds. For information on how to harden electronics and mechanics against these stress conditions, contact Kontron Support.

---

## Revision History

Revision	Brief Description of Changes	Date of Issue	Author/Editor
1.0	Initial Version	2018-Feb-22	MK
1.1	Removed noise data. Added No Legacy UEFI Only Info and, 9 <sup>th</sup> Gen. proc. Changed EN/ IEC 60950-1 to EN/IEC 62368, the Mechanical Dimensions Link, Type label and the Block Diagram.	2020-April-06	CW
1.2	Removed Ubuntu and added the new Logo	2023-Sept-15	CW

## Terms and Conditions

Kontron warrants products in accordance with defined regional warranty periods. For more information about warranty compliance and conformity, and the warranty period in your region, visit <https://www.kontron.com/terms-and-conditions>.

Kontron sells products worldwide and declares regional General Terms & Conditions of Sale, and Purchase Order Terms & Conditions. Visit <https://www.kontron.com/terms-and-conditions>.

For contact information, refer to the corporate offices contact information on the last page of this user guide or visit our website [CONTACT US](#).

## Customer Support

Find Kontron contacts by visiting: <https://www.kontron.com/support-and-services>.

## Customer Service

As a trusted technology innovator and global solutions provider, Kontron extends its embedded market strengths into a services portfolio allowing companies to break the barriers of traditional product lifecycles. Proven product expertise coupled with collaborative and highly-experienced support enables Kontron to provide exceptional peace of mind to build and maintain successful products.

For more details on Kontron's service offerings such as: enhanced repair services, extended warranty, Kontron training academy, and more visit <https://www.kontron.com/support-and-services>.

## Customer Comments

If you have any difficulties using this user guide, discover an error, or just want to provide some feedback, contact [Kontron Support](#). Detail any errors you find. We will correct the errors or problems as soon as possible and post the revised user guide on our website.

## Symbols

The following symbols may be used in this user guide

### **⚠ DANGER**

DANGER indicates a hazardous situation which, if not avoided, will result in death or serious injury.

### **⚠ WARNING**

WARNING indicates a hazardous situation which, if not avoided, could result in death or serious injury.

### **NOTICE**

NOTICE indicates a property damage message.

### **⚠ CAUTION**

CAUTION indicates a hazardous situation which, if not avoided, may result in minor or moderate injury.



Electric Shock!

This symbol and title warn of hazards due to electrical shocks (> 60 V) when touching products or parts of products. Failure to observe the precautions indicated and/or prescribed by the law may endanger your life/health and/or result in damage to your material.



ESD Sensitive Device!

This symbol and title inform that the electronic boards and their components are sensitive to static electricity. Care must therefore be taken during all handling operations and inspections of this product in order to ensure product integrity at all times.



HOT Surface!

Do NOT touch! Allow to cool before servicing.



Laser!

This symbol inform of the risk of exposure to laser beam and light emitting devices (LEDs) from an electrical device. Eye protection per manufacturer notice shall review before servicing.



This symbol indicates general information about the product and the user guide.

This symbol also indicates detail information about the specific product configuration.



This symbol precedes helpful hints and tips for daily use.

## For Your Safety

Your new Kontron product was developed and tested carefully to provide all features necessary to ensure its compliance with electrical safety requirements. It was also designed for a long fault-free life. However, the life expectancy of your product can be drastically reduced by improper treatment during unpacking and installation. Therefore, in the interest of your own safety and of the correct operation of your new Kontron product, you are requested to conform with the following guidelines.

### High Voltage Safety Instructions

As a precaution and in case of danger, the power connector must be easily accessible. The power connector is the product's main disconnect device.

#### ⚠ CAUTION

Warning

All operations on this product must be carried out by sufficiently skilled personnel only.

#### ⚠ CAUTION



Electric Shock!

Before installing a non hot-swappable Kontron product into a system always ensure that your mains power is switched off. This also applies to the installation of piggybacks. Serious electrical shock hazards can exist during all installation, repair, and maintenance operations on this product. Therefore, always unplug the power cable and any other cables which provide external voltages before performing any work on this product.

Earth ground connection to vehicle's chassis or a central grounding point shall remain connected. The earth ground cable shall be the last cable to be disconnected or the first cable to be connected when performing installation or removal procedures on this product.

### Special Handling and Unpacking Instruction

#### NOTICE



ESD Sensitive Device!

Electronic boards and their components are sensitive to static electricity. Therefore, care must be taken during all handling operations and inspections of this product, in order to ensure product integrity at all times.

#### ⚠ CAUTION

Handling and operation of the product is permitted only for trained personnel within a work place that is access controlled. Follow the "General Safety Instructions for IT Equipment" supplied with the product.

Do not handle this product out of its protective enclosure while it is not used for operational purposes unless it is otherwise protected.

Whenever possible, unpack or pack this product only at EOS/ESD safe work stations. Where a safe work station is not guaranteed, it is important for the operator to be electrically discharged before touching the product with his/her hands or tools. This is most easily done by touching a metal part of your system housing.

It is particularly important to observe standard anti-static precautions when changing piggybacks, ROM devices, jumper settings etc. If the product contains batteries for RTC or memory backup, ensure that the product is not placed on conductive surfaces, including anti-static plastics or sponges. They can cause short circuits and damage the batteries or conductive circuits on the product.

## Lithium Battery Precautions

If your product is equipped with a lithium battery, take the following precautions when replacing the battery.

### ▲ CAUTION

---

**CAUTION: Risk of Explosion if the lithium battery is replaced by an incorrect type. Dispose of used lithium batteries according to the Instructions.**

**ATTENTION: Risque d'explosion si la pile au lithium est remplacée par une pile de type incorrect. Éliminez les piles au lithium usagées conformément aux instructions.**

---

## General Instructions on Usage

In order to maintain Kontron's product warranty, this product must not be altered or modified in any way. Changes or modifications to the product, that are not explicitly approved by Kontron and described in this user guide or received from Kontron Support as a special handling instruction, will void your warranty.

Install the product only in or connected to systems that fulfill all necessary technical and specific environmental requirements. This also applies to the operational temperature range of the specific product version that must not be exceeded.

In performing all necessary installation and application operations, only follow the instructions supplied within this user guide.

Keep all the original packaging material for future storage or warranty shipments. If it is necessary to store or ship the product then re-pack the product in the same manner as the product was delivered.

Special care is necessary when handling or unpacking the product. Refer to any special handling and unpacking instruction within this user guide.

## Quality and Environmental Management

Kontron aims to deliver reliable high-end products designed and built for quality, and aims to complying with environmental laws, regulations, and other environmentally oriented requirements. For more information regarding Kontron's quality and environmental responsibilities, visit <http://www.kontron.com/about-kontron/corporate-responsibility/quality-management>.

## Disposal and Recycling

Kontron's products are manufactured to satisfy environmental protection requirements where possible. Many of the components used are capable of being recycled. Final disposal of this product after its service life must be accomplished in accordance with applicable country, state, or local laws or regulations.

## WEEE Compliance

The Waste Electrical and Electronic Equipment (WEEE) Directive aims to:

- ▶ Reduce waste arising from electrical and electronic equipment (EEE)
- ▶ Make producers of EEE responsible for the environmental impact of their products, especially when the product become waste
- ▶ Encourage separate collection and subsequent treatment, reuse, recovery, recycling and sound environmental disposal of EEE
- ▶ Improve the environmental performance of all those involved during the lifecycle of EEE



---

**Environmental protection is a high priority with Kontron.**  
Kontron follows the WEEE directive

---



# Table of Contents

Symbols.....	6
<b>For Your Safety</b> .....	<b>7</b>
High Voltage Safety Instructions .....	7
Special Handling and Unpacking Instruction .....	7
Lithium Battery Precautions.....	8
<b>General Instructions on Usage</b> .....	<b>8</b>
<b>Quality and Environmental Management</b> .....	<b>8</b>
Disposal and Recycling.....	8
WEEE Compliance.....	8
<b>Table of Contents</b> .....	<b>9</b>
<b>List of Tables</b> .....	<b>11</b>
<b>List of Figures</b> .....	<b>11</b>
<b>1/ General Safety Instructions</b> .....	<b>12</b>
1.1. Operation of Laser Source Devices.....	13
1.2. Electrostatic Discharge (ESD).....	13
1.2.1. Grounding Methods .....	14
1.3. Instructions for the Lithium Battery .....	14
<b>2/ Introduction</b> .....	<b>15</b>
<b>3/ Scope of Delivery</b> .....	<b>16</b>
3.1. Accessories and Spares parts.....	16
3.2. Shipment, Packaging and Unpacking.....	16
3.3. Type Label.....	16
<b>4/ Product Description</b> .....	<b>17</b>
4.1. Front Side.....	18
4.1.1. USB Ports .....	20
4.1.2. Controls and Indicators .....	20
4.1.3. Front Access Panel.....	21
4.1.4. Filter Pad and Filter Pad Holder.....	21
4.1.5. Drive Bays .....	22
4.2. Rear Side .....	23
4.2.1. Interfaces on the Rear Side .....	24
4.2.2. Power Supply Unit (PSU).....	25
4.2.3. Potential Equalization Stud .....	25
4.3. Sides (Left and Right).....	26
4.4. Cover .....	27
4.5. System Configuration .....	28
4.5.1. System Configuration with Mainboard and Expansion Cards.....	28
<b>5/ System Extension</b> .....	<b>29</b>
5.1. Mass Storage Options.....	29
5.2. Expansion Card.....	29
<b>6/ Thermal Considerations</b> .....	<b>30</b>
6.1. Active Cooling.....	30
6.1.1. Temperature Sensor .....	30
6.2. Minimum System Clearance .....	30
6.3. Third Party Components.....	30
<b>7/ Assembly</b> .....	<b>31</b>
7.1. Opening and Closing the Cover.....	31
7.2. Accessing Internal Components.....	32
7.2.1. Installing and Removing Expansion Cards .....	32
<b>8/ Installation</b> .....	<b>34</b>
8.1. Attaching the Rubber Feet .....	34

8.2. Removing the Handle Brackets .....	35
8.3. Removing the Front Access Panel and Front Access Panel Side-Plates .....	35
8.4. Installation as a Desktop .....	36
8.5. Installation in a 19" Industrial Rack .....	37
8.6. Installing Slide Rails (Option) .....	38
<b>9/ Starting Up.....</b>	<b>40</b>
9.1. Connecting the Power Connection .....	40
9.2. Operating System and Hardware Component Drivers .....	41
<b>10/ Maintenance and Prevention.....</b>	<b>42</b>
10.1. Cleaning the Filter Pad.....	42
10.2. Replacing the System Fans .....	43
10.3. Replacing the Lithium Battery.....	44
<b>11/ Technical Data .....</b>	<b>45</b>
11.1. Block Diagram .....	45
11.2. Technical Specification.....	46
11.3. Power Specification .....	47
11.4. Mechanical Specification.....	47
11.5. Environmental Specification.....	47
11.6. CE Directives and Standards.....	48
<b>12/ Standard Interfaces- Pin Assignments.....</b>	<b>49</b>
12.1. Keyboard Connector Pin Assignment .....	49
12.2. PS/2 Mouse Connector Pin Assignment .....	49
12.3. USB 2.0 Port Pin Assignment .....	49
12.4. Display Port Pin Assignment .....	50
12.5. COM 1 Connector Pin Assignment .....	50
12.6. DVI-D Connector Pin Assignment.....	50
12.7. LAN Connector Pin Assignment.....	51
12.8. USB 3.1 (Gen 1) Port and USB 3.1 (Gen2) Port Pin Assignment .....	51
12.9. Audio Jack Pin Assignment .....	51
<b>13/ Technical Support.....</b>	<b>52</b>
13.1. Returning Defective Merchandise .....	52
<b>14/ Storage and Transportation .....</b>	<b>54</b>
14.1. Storage.....	54
14.2. Transportation .....	54
<b>15/ Warranty.....</b>	<b>55</b>
15.1. Limitation/Exemption from Warranty Obligation .....	55
<b>16/ Disposal.....</b>	<b>56</b>
<b>List of Acronyms .....</b>	<b>57</b>
About Kontron .....	58

## List of Tables

Table 1: Scope of Delivery .....	16
Table 2: Accessories and Spares parts .....	16
Table 3: Power LED and HDD LED activity description.....	21
Table 4: Drive bays.....	22
Table 5: Mass Storage devices.....	29
Table 6: List of Acronyms .....	57

## List of Figures

Figure 1: Laser radiation warning label .....	13
Figure 2: Type label example.....	16
Figure 3: Rackmount variant (closed access panel).....	17
Figure 4: Desktop variant (closed access panel).....	17
Figure 5: Rackmount variant (opened access panel) .....	17
Figure 6: Desktop variant (opened access panel) .....	17
Figure 7: Front side with front access panel closed .....	18
Figure 8: Handle bracket with fastening screws .....	18
Figure 9: Front side with front access panel open.....	19
Figure 10: Power Button and USB 2.0 ports.....	20
Figure 11: LED indicators.....	21
Figure 12: Rear side with micro-ATX mainboard + riser card).....	23
Figure 13: External interfaces KISS 1U Short V3 CFL .....	24
Figure 14: PSU 400W .....	25
Figure 15: Potential equalization stud .....	25
Figure 16: Side view.....	26
Figure 17: Cover underside.....	27
Figure 18: Example of KISS 1U Short V3 configuration with mainboard and low-profile expansion card.....	28
Figure 19: Loosening the knurled fastening screws on the rear side .....	31
Figure 20: Pull and release the cover .....	31
Figure 21: Removing the cover .....	31
Figure 22: Rear side with slide bracket closed (for fixing the expansion card/slot bracket).....	32
Figure 23: Rear side with slide bracket (opened) .....	33
Figure 24: PCIe card installed into PCIe card slot .....	33
Figure 25: Handle bracket with front access panel side-plate .....	35
Figure 26: Removing the front access panel.....	35
Figure 27: Attaching slide rail inner part to KISS 1U Short V3 chassis .....	38
Figure 28: KISS 1U Short V3 with slide rail in pulled-out position .....	38
Figure 29: KISS 1U Short V3 with slide rail in pushed-in position.....	38
Figure 30: Assembling the slide rails in an industrial rack cabinet .....	39
Figure 31: Input power socket .....	40
Figure 32: Front side with filter pad holder and filter pad .....	42
Figure 33: Front side without Filter pad holder.....	42
Figure 34: Filter pad holder (without filter pad).....	42
Figure 35: Filter pad .....	42
Figure 36: Fan assembly with power and control cables .....	44
Figure 37: Block diagram KISS 1U Short V3 CFL .....	45

# 1/ General Safety Instructions

Please read this passage carefully and take careful note of the instructions, which have been compiled for your safety and to ensure to apply in accordance with intended regulations. If the following general safety instructions are not observed, it could lead to injuries to the operator and/or damage of the product; in cases of non-observance of the instructions Kontron Europe is exempt from accident liability, this also applies during the warranty period.

The product has been built and tested according to the basic safety requirements for low voltage (LVD) applications and has left the manufacturer in safety-related, flawless condition. To maintain this condition and to also ensure safe operation, the operator must not only observe the correct operating conditions for the product but also the following general safety instructions:

- ▶ The product must be used as specified in the product documentation, in which the instructions for safety for the product and for the operator are described. These contain guidelines for setting up, installation and assembly, maintenance, transport or storage.
- ▶ The on-site electrical installation must meet the requirements of the country's specific local regulations.
- ▶ If a power cable comes with the product, only this cable should be used. Do not use an extension cable to connect the product.
- ▶ To guarantee that sufficient air circulation is available to cool the product, please ensure that the ventilation openings are not covered or blocked. If a filter mat is provided, this should be cleaned regularly. Do not place the product close to heat sources or damp places. Make sure the product is well ventilated.
- ▶ Only connect the product to an external power supply providing the voltage type (AC or DC) and the input power (max. current) specified on the Kontron Product Label and meeting the requirements of the Limited Power Source (LPS) and Power Source (PS2) of UL/IEC 62368-1.
- ▶ Only products or parts that meet the requirements for Power Source (PS1) of UL/IEC 62368-1 may be connected to the product's available interfaces (I/O).
- ▶ Before opening the product, make sure that the product is disconnected from the mains.
- ▶ Switching off the product by its power button does not disconnect it from the mains. Complete disconnection is only possible if the power cable is removed from the wall plug or from the product. Ensure that there is free and easy access to enable disconnection.
- ▶ The product may only be opened for the insertion or removal of add-on cards (depending on the configuration of the product). This may only be carried out by qualified operators.
- ▶ If extensions are being carried out, the following must be observed:
  - ▶ all effective legal regulations and all technical data are adhered to
  - ▶ the power consumption of any add-on card does not exceed the specified limitations
  - ▶ the current consumption of the product does not exceed the value stated on the product label
- ▶ Only original accessories that have been approved by Kontron Europe can be used.
- ▶ Please note: safe operation is no longer possible when any of the following applies:
  - ▶ the product has visible damages or
  - ▶ the product is no longer functioning
 In this case the product must be switched off and it must be ensured that the product can no longer be operated.
- ▶ Handling and operation of the product is permitted only for trained personnel within a work place that is access controlled.
- ▶ CAUTION: Risk of explosion if the lithium battery is replaced incorrectly (short-circuited, reverse-poled, wrong battery type). Dispose of used batteries according to the manufacturer's instructions.
- ▶ This product is not suitable for use in locations where children are likely to be present

## Additional Safety Instructions for DC Power Supply Circuits

- ▶ To guarantee safe operation, please observe that:
  - ▶ the external DC power supply must meet the criteria for LPS and PS2 (UL/IEC 62368-1)

- ▶ no cables or parts without insulation in electrical circuits with dangerous voltage or power should be touched directly or indirectly
  - ▶ a reliable functional earth connection is provided
  - ▶ a suitable, easily accessible disconnecting device is used in the application (e.g. overcurrent protective device), if the product itself is not disconnectable
  - ▶ a disconnect device, if provided in or as part of the product, shall disconnect both poles simultaneously
  - ▶ interconnecting power circuits of different products cause no electrical hazards
- ▶ A sufficient dimensioning of the power cable wires must be selected – according to the maximum electrical specifications on the product label – as stipulated by EN62368-1 or VDE0100 or EN60204 or UL61010-1 regulations.

## 1.1. Operation of Laser Source Devices

Figure 1: Laser radiation warning label

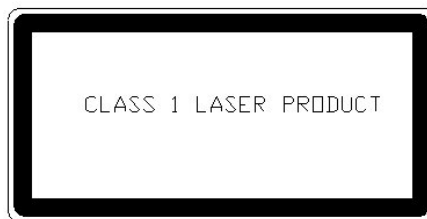

The optional DVD drive contains light-emitting diodes (LEDs) (classified in accordance with IEC 60825-1:2007: LASER CLASS 1) and therefore must not be opened. If the enclosure of such a drive is opened, invisible laser radiation is emitted. Do not allow yourself to be exposed to this radiation.

The laser system meets the Code of Federal Regulations (CFR), Title 21, 1040 -Performance standards for light-emitting products.



---

### Laser!

Risk of exposure to invisible laser radiation when opening DVD drive

- ▶ Do not open DVD drive due to invisible laser radiation
  - ▶ Check manufacture instructions eye protection maybe required
- 

## 1.2. Electrostatic Discharge (ESD)



---

A sudden discharge of electrostatic electricity can destroy static-sensitive devices.

---

Proper packaging and grounding techniques are necessary precautions to prevent damage. Always take the following precautions:

1. Transport boards in ESD-safe containers such as boxes or bags.
2. Keep electrostatic sensitive parts in their containers until they arrive at the ESD-safe workplace.
3. Always be properly grounded when touching sensitive board, component, or assembly.
4. Store electrostatic-sensitive boards in protective packaging or on antistatic mats.

### 1.2.1. Grounding Methods

To avoid electrostatic damage, observe the following grounding guidelines:

1. Cover workstations with approved antistatic material. Always wear a wrist strap connected to workplace. Always use properly grounded tools and equipment.
2. Use antistatic mats, heel straps, or air ionizers for more protection.
3. Always handle electrostatically sensitive components by their edge or by their casing.
4. Avoid contact with pins, leads, or circuitry.
5. Switch off power and input signals before inserting and removing connectors or connecting test equipment.
6. Keep work area free of non-conductive materials such as ordinary plastic assembly aids and Styrofoam.
7. Use only field service tools that are conductive, such as cutters, screwdrivers, and vacuum cleaners.
8. Always place drives and boards PCB-assembly-side down on the foam.

### 1.3. Instructions for the Lithium Battery

When replacing the mainboard's lithium battery observe the instructions described in Chapter 10.3 "Replacing the Lithium Battery".

#### **CAUTION**

---

**CAUTION:** Risk of Explosion if the lithium battery is replaced by an incorrect type. Dispose of used lithium batteries according to the Instructions.

**ATTENTION:** Risque d'explosion si la pile au lithium est remplacée par une pile de type incorrect. Éliminez les piles au lithium usagées conformément aux instructions.

---



---

Do not dispose of lithium batteries in general trash collection. Dispose of the battery according to the local regulations dealing with the disposal of these special materials, (e.g. to the collecting points for dispose of batteries).

---

## 2/ Introduction

This user guide focuses on describing the special features of the KISS 1U Short V3 made by Kontron. New users are recommended to study the instructions within this user guide before switching on the power.

The KISS 1U Short V3 is a scalable 1U rackmount system equipped with micro-ATX mainboard, using Intel's® 8<sup>th</sup> /9<sup>th</sup> generation processors and supporting multiple expansion capabilities and external interfaces.

The KISS 1U Short V3 is designed for high performance, reliability and use in in harsh Industrial environments offering total flexibility with installation options in a 19" industrial rack or on a desktop.

General KISS 1U Short V3 CFL features are:

- ▶ micro-ATX mainboard
- ▶ Supporting Intel® Core™ i3, i5 and i7 series, 8<sup>th</sup>/9<sup>th</sup> generation
- ▶ Intel® C246 Express chipset
- ▶ Up to 64 GB memory with 4x DDR4 UDIMM
- ▶ Expansion slots: 1x PCIe x16 slot (low profile)
- ▶ Mass storage capabilities with M.2 ,HDD, SSD and DVD devices
- ▶ External Interfaces for mouse, keyboard, 4x USB 2.0, 4x USB 3.1, 2x DP 1.2 , DVI-D, serial port, 2x 1 Gb Ethernet, audio, keyboard and mouse
- ▶ Active cooling

### 3/ Scope of Delivery

Check that your delivery is complete, and contains the items listed in Table 1: Scope of Delivery. If damaged or missing items are discovered, contact the dealer.

Table 1: Scope of Delivery

Part	Qty.	Part Description
KISS 1U Short V3	1	System configuration as ordered
Rubber feet	4	Self-adhesive
AC power cable	1	With Europe rating, other cable ratings are optional
Safety instructions	1	Safety Instructions for IT equipment

### 3.1. Accessories and Spares parts

Table 2: Accessories and Spares parts

Accessories	Part Number	Part Description
	1016-5807	Slide rails
	1051-7200	Mounting kit slide rail
Spare parts	1057-4138	Filter pad
	1065-0865	Fan assembly

### 3.2. Shipment, Packaging and Unpacking

The KISS 1U Short V3 is packed together with all standard parts in a product specific cardboard packaging with suitable shock absorbers inside. Each item is packaged separately.

### 3.3. Type Label

Figure 2: Type label example





## 4/ Product Description

The KISS 1U Short V3 expands the Kontron KISS computer line. The KISS 1U Short V3 is a scalable 1U (19") system equipped with a micro-ATX mainboard. The flexible customer-specific hardware system configuration and the robust construction with excellent mechanical stability offers the superior qualities of a computer designed for operation in harsh industrial environment.

The KISS 1U Short V3's design enables installation in 19" industrial racks or as a desktop.

Figure 3: Rackmount variant (closed access panel)



Figure 4: Desktop variant (closed access panel)



Figure 5: Rackmount variant (opened access panel)



Figure 6: Desktop variant (opened access panel)



---

The KISS 1U Short V3 is design for horizontal operation. Vertical operation is possible.

---

The KISS 1U Short V3 can be equipped with up to two drive bays D1 and D2 (depending on the system configuration):

- ▶ **D1:** drive Bay for one 5.25" front accessible slim-line drive (option 1)  
or up to three removable 2.5" drives (option 2)
- ▶ **D2:** drive bay for one 2.5" internal drive (option 1, option 2)

The power button is located on the front side behind the front access panel. The LED indicators are located on the front side and consist of a power LED and a hard disk activity LED.

The KISS 1U Short V3 is delivered with a 400 W Power Supply Unit (PSU) with an input voltage range of 100 V to 240 V.

Two system fans are installed at the front side of the product. The two system fans are protected against dust and dirt by a washable filter pad located on the front side of the product. This filter pad can be replaced during operation.

The KISS 1U Short V3 can be expanded with different expansion cards (1 expansion slot).

When powering on the KISS 1U Short V3, make sure that the air intake and exhaust openings are not obstructed by objects.

## 4.1. Front Side

The front side consists of two handle brackets for installation in a 19" industrial rack and a front access panel with two front access panel side-plates attached via the handle brackets.

Figure 7: Front side with front access panel closed

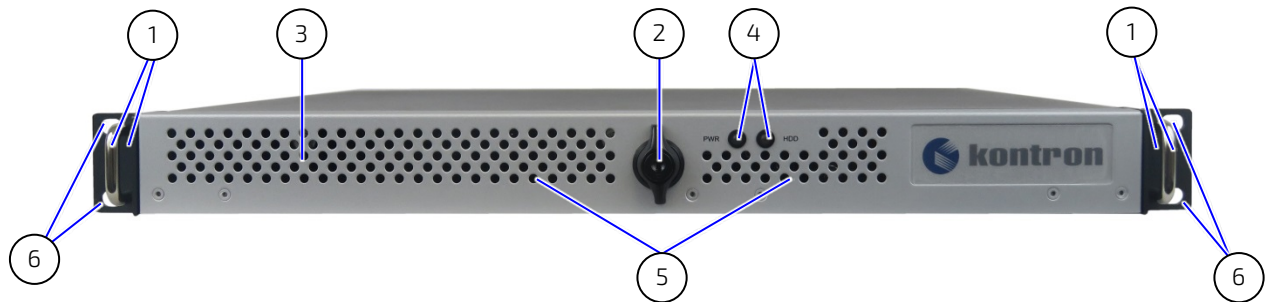

- |  |   |
|--|---|
| 1. Handle bracket                      | 4. LED indicators                         |
| 2. Key lock for the front access panel | 5. Ventilation holes                      |
| 3. Front access panel                  | 6. Handle Bracket 19" rack mounting holes |

For use as a desktop system, removing the two handle brackets (right side and left side), see Chapter 8.2: Removing the Handle Brackets and attach the rubber feet (included in delivery), see Chapter 7.1: "Opening and Closing the Cover"

Figure 8: Handle bracket with fastening screws

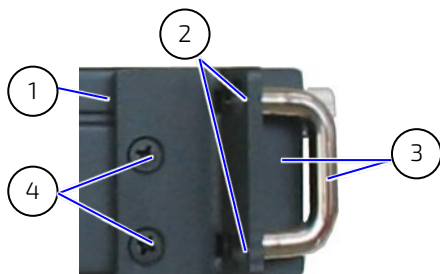

- |                                    |   |
|------------------------------------|---|
| 1. KISS 1U Short V3 chassis        | 3. Handle bracket                                 |
| 2. Holes for mounting in 19" racks | 4. Screws to fasten handle bracket to the chassis |

The power button, LED Indicators, two USB 2.0 ports, a filter pad holder and the integrated drives are located on the front side behind the front access panel.

Figure 9: Front side with front access panel open

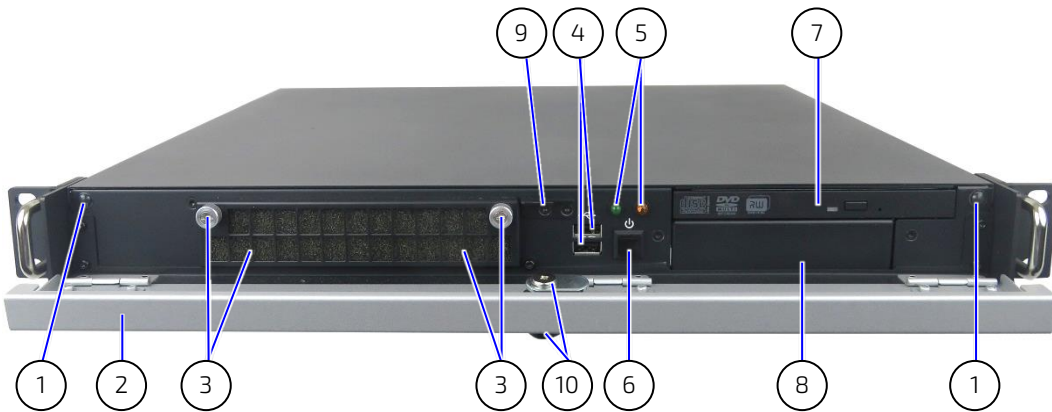

- |  |   |
|--|---|
| 1. Bump stop for the front access panel  | 7. <b>D1:</b> drive Bay for one 5.25" front accessible slim-line drive ( <i>option 1</i> )<br><b>or</b> up to three removable 2.5" drives ( <i>option 2</i> ) |
| 2. Front access panel                    | 8. <b>D2:</b> drive bay for one 2.5" internal drive ( <i>option 1, option 2</i> )   |
| 3. Filter pad holder with knurled screws | 9. Slot for the locking mechanism   |
| 4. 2x USB (2.0) ports                    | 10. Locking mechanism on front access panel   |
| 5. Indicators (power and HDD LED)        |   |
| 6. Power button                          |   |

## 4.1.1. USB Ports

The two USB 2.0 ports are located on the front side of the product (Figure 9, pos.10 and Figure 10, pos. 2), behind the front access panel.

Figure 10: Power Button and USB 2.0 ports

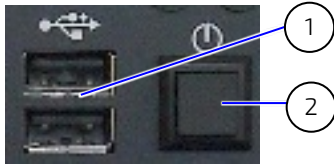

1. USB 2.0 ports
2. Power button



---

If USB devices are connected to the USB ports on the front side, the front access panel cannot be closed and locked.

---

## 4.1.2. Controls and Indicators

### 4.1.2.1. Power Button

The power button (Figure 9, pos. 6 and Figure 10, pos. 2) is located on the front side of the product, behind the front access panel. Press this button to switch on or to switch off the product.

By pressing the power button for longer than four seconds initiates a forced system shutdown before the power to the product is switched off.

#### **⚠ WARNING**

---

The power button does not disconnect from the mains power supply. When switched off using the power button there is still a standby voltage of 5 VSB on the mainboard.

---

#### **⚠ WARNING**

---

AC Power cable and power connectors must always remain easily accessible. The KISS 1U ShortV3 is only completely disconnected from the mains power supply when the AC power cable is disconnected from the mains power socket or the KISS 1U Short V3's input power socket (Figure 12, pos. 7).  
If the end environment restricts access to power cable, disconnection must be guaranteed using a separate cut-off fixture.

---

#### **NOTICE**

---

Performing a forced shutdown can lead to loss of data or other undesirable effects!

---

### 4.1.2.2. Power LED and HDD Activity LED

The LED indicators (Figure 9, pos. 5 and Figure 11) are located on the front side of the product, behind the front access panel.

Figure 11: LED indicators



- 1. Power LED
- 2. HDD activity LED

Table 3: Power LED and HDD LED activity description

LED	Description
<b>Power LED (green)</b>	LED illuminates (green) when the product is switched on by pressing the power button. Prerequisite: Connection to an appropriate AC/DC power source.
<b>HDD LED (orange)</b>	LED lights up during hard disk activity

### 4.1.3. Front Access Panel

The securing lock mechanism (Figure 7, pos. 2) located on the front access panel protects against unauthorized use. When locked the front access panel cannot be opened, and the drives, filter pad holder and power button are not accessible.

The KISS 1U Short V3 can be operated without the front access panel, see Chapter 8.3: Removing the Front Access Panel and Front Access Panel Side-Plates.



---

Front access panel key must be kept safe and not be accessible to unauthorized persons.

---



---

If USB devices are connected to the USB ports on the front side, the front access panel door cannot be closed and locked.

---

### 4.1.4. Filter Pad and Filter Pad Holder

The filter pad and the filter pad holder (Figure 9, pos. 3) are located behind the front access panel (Figure 7, pos. 2). The filter pad protects the product from dust and dirt and will over time become soiled by pollution. If heavily soiled, the filter pad can cause excessive heating of the product. Kontron recommends cleaning the filter pad as often as necessary, see Chapter 10.1: Cleaning the Filter Pad.



---

The filter pad can be changed during operation.

---

The filter pad inserts into the filter pad holder and then the filter pad holder is fastened to the chassis via two knurled screws and two positioning latches

### 4.1.5. Drive Bays

The KISS 1U Short V3 can be equipped with up to two drive bays. Drive bays D1 and D2 are front accessible (Figure 9, pos.7 and 8) and used separately or configured as a RAID array using the mainboard's chipset RAID.

**Table 4: Drive bays**

Drive Bay	Location	Description
D1	Front accessible	One 5.25" DVD slim-line drive bay <b>or</b> one 3.5" SATA drive bay
D2	Internal	One 2.5" internal SATA drive bay



---

**Refer to the chipset specification for the RAID type and Intel® Rapid Storage Technology availability.**

---

For additional storage, use the on-board M.2 slot with a M.2 memory module, see Chapter 5/System Extension.

## 4.2. Rear Side

The rear panel includes the external interfaces of the integrated mainboard, any additional interfaces of the expansion card, the power supply unit (PSU), and the air exhaust openings.



The positioning and number of the interfaces varies depending on the system configuration.

Figure 12: Rear side with micro-ATX mainboard + riser card)

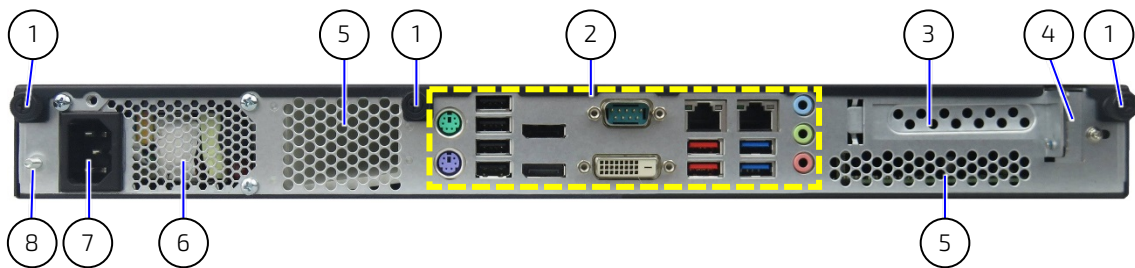

- |                                       |                                |
|---------------------------------------|--------------------------------|
| 1. Knurled screws to secure the cover | 5. Air exhaust openings        |
| 2. External Interfaces of mainboard   | 6. PSU air exhaust openings    |
| 3. PCIe x16 free expansion card slot  | 7. Input power socket          |
| 4. Slide bracket with fixing screws   | 8. Potential equalization stud |

## 4.2.1. Interfaces on the Rear Side

Depending on the installed mainboard, the following external interfaces are available for peripherals.

### 4.2.1.1. External Interfaces KISS 1U Short V3 CFL

Figure 13: External interfaces KISS 1U Short V3 CFL

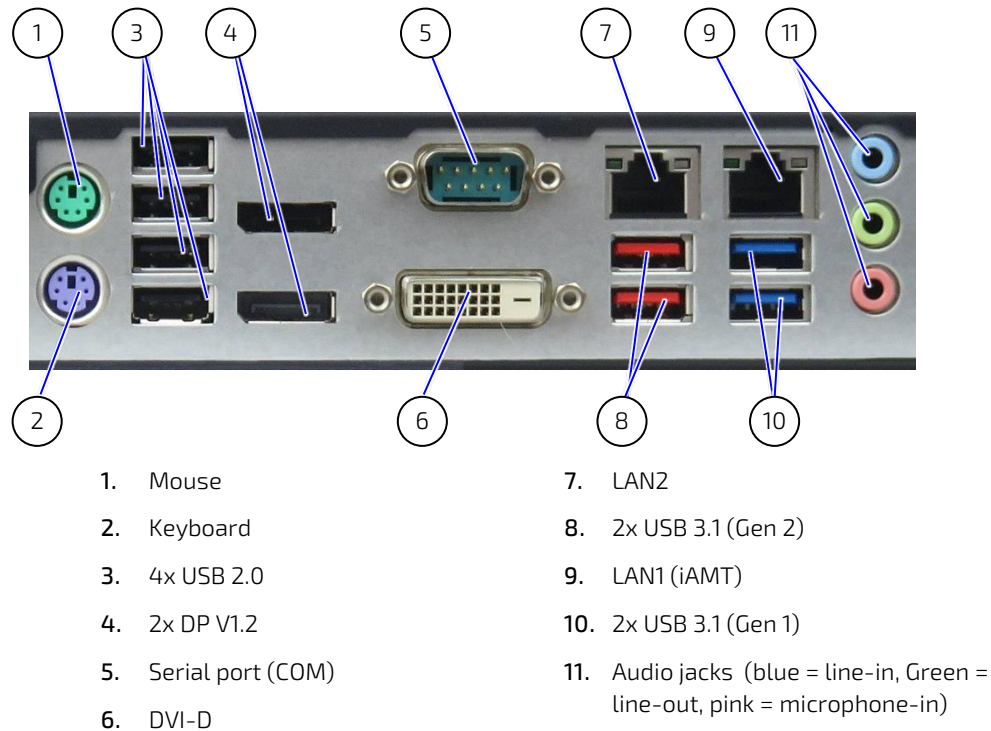



## 4.2.2. Power Supply Unit (PSU)

The Power Supply Unit (PSU) is located on the rear side of the product and supplies the required internal 12V, 5V and 3.3V voltages using standard certified cabling. The KISS1U Short V3 supports a 400 W PSU with a nominal Inputs voltage range 100 V to 240 V. For more information, see Chapter 11.3: Power Specification.

### ⚠ WARNING

Even when switched off using the power button parts of the product may still be energized! The product is only completely switched off by switching off power using the power button and disconnecting the power cable from the mains power supply or Input power socket.

### ⚠ WARNING

AC Power cable and power connectors must always remain easily accessible. If the end environment restricts access to the power cable, disconnection must be guaranteed using a separate cut-off fixture.

### NOTICE

Do not disconnect the power from the product while the product is switched on! Performing a forced shut down may lead to loss of data or other undesirable effects! Switch off using the power button to perform an orderly shutdown without data loss.

Figure 14: PSU 400W



The 400 W PSU is a single PSU. A redundant PSU is not supported.

## 4.2.3. Potential Equalization Stud

The potential equalization stud is located on the rear side (Figure 12, pos. 8). The potential equalization stud is not a ground connection. When connected the potential equalization stud ensures that all connected systems share a common potential.



The potential equalization stud is not a ground connection. The potential equalization stud ensures that all connected systems share a common potential.

Figure 15: Potential equalization stud



### 4.3. Sides (Left and Right)

On the left and right sides of the KISS 1U Short V3, there are four M4 tapped screw holes (Figure 16, pos. 2). used for installation in a 19" industrial rack with slide rails (Figure 16, pos. 2).

Figure 16: Side view

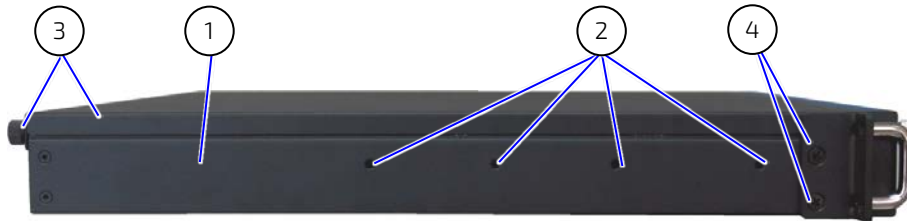

- |   |  |
|---|--|
| 1. Left side of the KISS 1U Short V3 (right side is identical to left side) | 3. Cover with captive knurled screws (to secure the cover) |
| 2. 4x M4 tapped holes (on both sides)                                       | 4. Handle bracket screws                                   |



---

The right side is a mirrored version of the left side.

---

## 4.4. Cover

### **⚠WARNING**

Energy hazards-240 VA present inside the chassis!

Before removing the top cover. Switch off the product properly by using the power switch on the front side and disconnecting the power cable from the mains power supply.

### **⚠WARNING**

Recommended intended used is closed and locked

Only when the cover is secured is it ensured that the operator do not have access to the internal parts, loaded with hazardous energy. To close properly secure the cover knurled screws: one front side screw and three rear side screws.

The cover fixes to the main chassis using three fixing brackets at the front side of the cover and three fixing brackets with captive knurled screws on the rear side of the cover of the KISS 1U Short V3.

When closing the cover, make sure that:

- ▶ Front side
  - ▶ Cover's fixing brackets (Figure 17, pos. 4) are inserted properly into the corresponding retaining brackets (Figure 18, pos. 5) of the main chassis.
- ▶ All fastening screws are secured
  - ▶ Three knurled screws (Figure 17, pos. 1) on the rear side

Figure 17: Cover underside

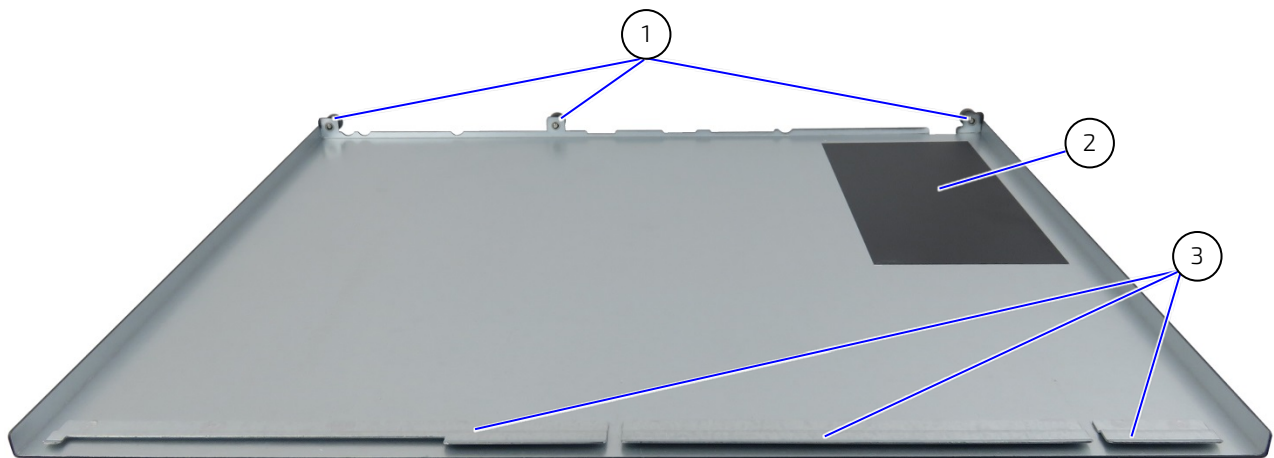

- |                               |                             |
|-------------------------------|-----------------------------|
| 1. 3x knurled screws          | 3. 3x front fixing brackets |
| 2. Insulation foil (Makrolon) |                             |

## 4.5. System Configuration

### 4.5.1. System Configuration with Mainboard and Expansion Cards

Figure 18: Example of KISS 1U Short V3 configuration with mainboard and low-profile expansion card



- |  |  |
|--|--|
| 1. Handle bracket  | 7. PCIe-slot for low-profile expansion card  |
| 2. Cover retaining plate on the front side   | 8. Slide bracket with fixing screws          |
| 3. <b>D1</b> and <b>D2</b> : drives bays (stacked one above the other into a drive cage) | 9. Mainboard                                 |
| 4. Power Supply Unit (AC)  | 10. Fan assembly (equipped with two fans)    |
| 5. Cover retaining plates on the rear side   | 11. Front access panel with fastening screws |
| 6. Ventilation outlet of the CPU fan   |  |

## 5/ System Extension



---

Due to the limited lifespan of expansion devices, Kontron recommends checking the condition of any installed expansion devices regularly and to pay attention to the manufacturer's lifespan specifications.

---

### 5.1. Mass Storage Options

For product variants with a mainboard including an on-board M.2 slot for a M.2 2280 memory module. An optional internal drive is configurable. RAID support is not available for an installed M.2 memory module.

**Table 5: Mass Storage devices**

Drive Bay/Slot		Description
On-board slot	M.2 slot	Internal M2.2280 PCIe drive



---

RAID support is not available for the on-board M.2 memory module.

---

### 5.2. Expansion Card

The KISS 1U Short V3 can be expanded with a PCIe x16, low-profile expansion card using the expansion slot available on the rear side.



---

Before extending the product with expansion cards consider the maximum power consumption allowed by the PSU.

---

## 6/ Thermal Considerations

### 6.1. Active Cooling

The KISS 1U Short V3 is forced air-cooled using two internal system fans that force air to flow from the front to the back of the chassis. The processor and extension cards have integrated cooling solutions or are equipped with the corresponding cooling devices. If a filter pad is used, cleaned the filter pad regularly to ensure that sufficient air flow is provided, see Chapter 10.1 "Cleaning the Filter Pad".

#### 6.1.1. Temperature Sensor

The temperature conditions of the product (depending on the environmental temperature and the system load) are detected by temperature sensors on the mainboard that control the system fans accordingly.

### 6.2. Minimum System Clearance

To guarantee that sufficient air flows from the front to the back of the chassis, ensure that the ventilation openings are not covered, blocked by obstructions from surrounding parts.

Before installing the KISS 1U Short V3 take into account, any thermal considerations mentioned in Chapter 8/: Installation, such as airflow obstructions and correct mount orientation.

#### **⚠ WARNING**

---

Ensure sufficient Air Flow

Ensure that the 19" industrial rack cabinet is well ventilated and does not prevent the KISS 1U Short V3 from sucking air at the front and exhausting air at the rear.

---

#### **⚠ WARNING**

---

Do not place the product close to heat sources or damp places.

---



---

There are no ventilation restrictions above and below the product, enabling installation directly on top of or below another system.

---

### 6.3. Third Party Components

When the KISS 1U Short V3 is extended and configured with third party components such as PCIe expansion cards, M.2 expansion cards, DIMMs and hard drives (HDD, SSD and DVD), there is an internal temperature rise. Thus, the air temperature inside the product is higher than the ambient air temperature around the product.

## 7/ Assembly

No special tools are required to open the KISS 1U Short V3. Before opening the KISS 1U Short V3 observe the instructions within this chapter.

### **⚠ WARNING**

Energy hazards-240 VA present inside the chassis!

Before removing the top cover. Switch off the product properly using the power switch on the front side and disconnecting the power cable from the mains power supply.

### **⚠ WARNING**

Recommended intended used is closed and locked

Only when the cover is secured is it ensured that the operator does not have access to the internal parts, loaded with hazardous energy. To close properly secured using all knurled screws: one front side and three rear side.

### 7.1. Opening and Closing the Cover

To access internal components, open the cover. To open the cover, proceed as follows:

1. Switch off and disconnect the product from the mains power supply.
2. Loosen the cover's three knurled screw (on the rear side) that secure the cover, as shown in Figure 19.

Figure 19: Loosening the knurled fastening screws on the rear side



3. Pull the cover out slightly as shown in Figure 20 to release the cover's fixing brackets (Figure 17 pos.3) from the retaining brackets of the chassis (Figure 18, pos. 4).

Figure 20: Pull and release the cover

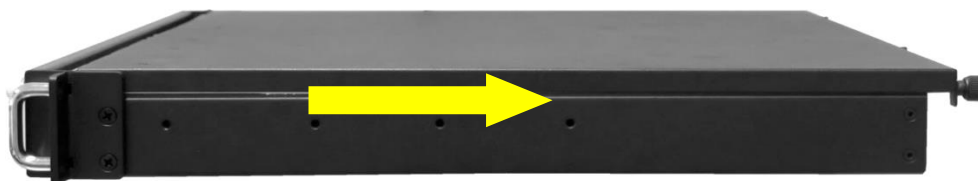

4. Lift the cover up (on the rear edge) and remove it as shown in Figure 21.

Figure 21: Removing the cover



- To close and secure the cover, proceed in the reverse order (step 4 to step 2).

**⚠ WARNING**

To close properly secured using all kurnled screws: one front side and three rear side.

## 7.2. Accessing Internal Components

This chapter contains important information on working safely with internal components. Follow these instructions when handling internal components and observe the corresponding safety instruction included in Chapter 1/: General Safety Instructions for IT Equipment.

**⚠ WARNING**

Energy hazards-240 VA present inside the chassis!

Before removing the top cover. Switch off the product properly using the power switch on the front side and disconnecting the power cable from the mains power supply.

**⚠ WARNING**

Activities requiring internal access of the product must be performed by trained personnel aware of the associated dangers



ESD Sensitive Device!

Follow the safety instructions for components that are sensitive to electrostatic discharge (ESD). Failure to observe this warning notice can result in damage to the components.



Consult the documentation provided by the expansion card's manufacturer for instructions before installing/removing an expansion card.

### 7.2.1. Installing and Removing Expansion Cards

To install or remove an expansion card, performing the following steps:

- Switch off and disconnect the product from the main's power supply.
- Open the cover as described in Chapter 7.1: Opening and Closing the Cover.
- To remove the slot or card bracket, remove the screw (Figure 22, pos. 2). Retain the screw for later use. Loosen (turn 1/2 to the left, do not remove the screw) the fastening screw (Figure 22, pos. 4) to unlock the slide bracket (Figure 22, pos. 3).

Figure 22: Rear side with slide bracket closed (for fixing the expansion card/slot bracket)



- |  |   |
|--|---|
| 1 Slot bracket of the add-on card installed                    | 3 Slide bracket                         |
| 2 Fastening screws for the slot bracket<br>(card slot bracket) | 4 Fastening screw for the slide bracket |





Only loosen the fastening screw (Figure 22, pos. 4) for the slide bracket (Figure 22, pos. 3)!  
Do not remove the screw!

4. Move the slide bracket to the right. The slot bracket is disengaged now and can be removed from the product.

Figure 23: Rear side with slide bracket (opened)



5. Insert/remove the expansion card into/out of the PCIe slot.
6. Position the bracket of the expansion card or the slot bracket at the rear side of the chassis.
7. Move the slide bracket (Figure 22, pos. 3) to the left until it rests firmly on the bracket of the expansion card or the slot bracket, respectively.
8. Lock the slide bracket in this position by fastening the screw removed in step 3 (Figure 22, pos. 2) firmly.
9. Secure the slide bracket position with the fastening screw (Figure 22, pos. 4)

Figure 24: PCIe card installed into PCIe card slot

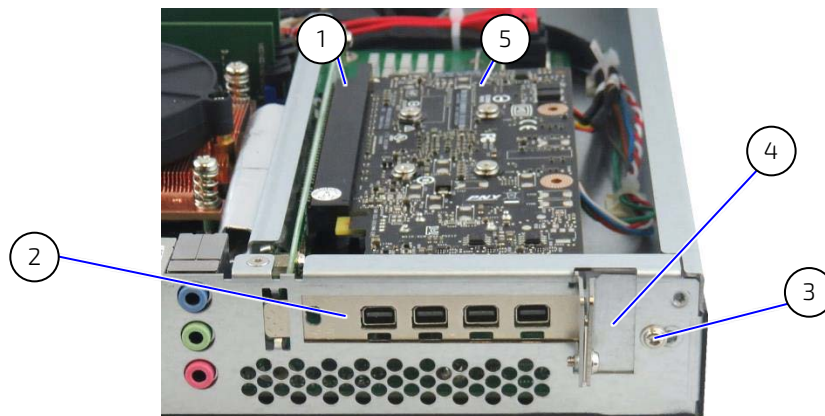

1. Expansion slot for 1x PCIe x16 expansion card
  2. Slot bracket of the PCIe card installed
  3. Fastening screw of the slide bracket
  4. Slide bracket (closed)
  5. PCIe card
10. Close the product and secure the cover with the knurled screws as described in Chapter 7.1: Opening and Closing the Cover.

## 8/ Installation

The KISS 1U Short V3 is designed for horizontal installation in a 19" industrial rack cabinet with the top cover facing upwards. There are no ventilation holes on the top and bottom side of the product, enabling installation directly on top of or below other systems in the 19" industrial rack cabinet

Before installing or removing the KISS 1U Short V3 in a 19" industrial rack cabinet or desktop environment, read the instructions and warnings in this chapter and observe the information in Chapter 1/:General Safety Instruction for IT Equipment. Due to possible access restrictions, Kontron recommends installing all expansion cards and connecting all peripherals to the corresponding system ports before installing in the end environment.

### **⚠ WARNING**

#### Ensure Sufficient Airflow

Ensure the KISS 1U Short V3 is well ventilated and does not prevent the KISS 1U Short V3 from taking in air at the front and exhausting air at the rear.

### **⚠ WARNING**

Do not place the product close to heat sources or damp places.

### **⚠ WARNING**

The product must be mounted and installed only by qualified personnel aware of the associated dangers.

### **⚠ CAUTION**

Before connecting any I/O cables. Ensure that the product is switched off and the power cable is disconnected connected from the power connector or mains power.

### **⚠ CAUTION**

When connecting cables, following proper cabling procedures:

1. Grounding pin is connected first and disconnected last
2. Connect all I/O cables
3. Power connection is the last connection



The KISS 1U Short V3 is design for horizontal operation. Vertical operation is possible..



Due to possible access is restrictions, before installing the product install all expansion cards and connect required peripherals to the corresponding system port.

### 8.1. Attaching the Rubber Feet

For use on a desktop, to avoid scratching the surface, attach the supplied four rubber feet:

1. Close your applications and perform an orderly shutdown (graceful shutdown).
2. Switch off the product and disconnect the product from the mains power supply. Disconnect all peripherals.
3. Ensure that all components are securely installed and that the cover is closed and secured.
4. Turn the chassis upside down (bottom side facing upwards)..

5. Remove the protective film from the self-adhesive rubber feet.
6. Attach the self-adhesive rubber feet to the bottom side of the chassis.

## 8.2. Removing the Handle Brackets

The two handles brackets are removable. To remove the two handle brackets, proceed as follows: To remove the two handles brackets (right side and left side) perform the following steps:

1. Loosen and remove the two screws (Figure 8, pos. 4) that fasten the handle brackets and the front access panel side-plates to the chassis (left side, right side).
2. Remove the handle bracket.
3. Reattach the two front access panel side-plates using the original two screws (left side, right side).
4. Store the two handle brackets for possible further use.

Figure 25: Handle bracket with front access panel side-plate

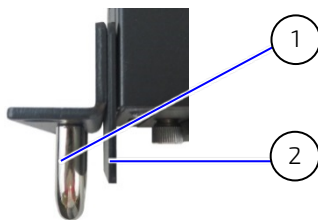

1. Bracket handle
2. Front access panel side-plate



---

The KISS 1U Short V3 is delivered with the handle brackets already assembled.

---

## 8.3. Removing the Front Access Panel and Front Access Panel Side-Plates

The front access panel and the two front access panel side-plates are removable.

Figure 26: Removing the front access panel



- 1 Hinges of the front access panel
- 2 Opened front access panel

To remove the front access panel and the two front access panel side-plates, proceed as follows:

1. Open the front access panel. The front access panel is mounted to the chassis with three hinges (see Figure 26, pos. 1)
2. Turn the product upside down. From the bottom side, remove 3x 2 screws to dismount the hinges from the chassis (yellow markings in Figure 26).
3. Remove the front access panel from the chassis.
4. Store the front access panel for possible further use.

## 8.4. Installation as a Desktop

Before installing the KISS 1U Short V3 in a desktop environment, install the rubber feet as described in Chapter 8.1: Attaching the Rubber Feet, to avoid scratching the installation surface.

Additionally, observe the general instructions and any safety warnings within this chapter.

### **⚠ WARNING**

---

The voltage feeds must not be overloaded.

Adjust the cabling and the external overcharge protection to correspond with the electrical data indicated on the type label located on right side of the chassis.

---

### **⚠ WARNING**

---

Ensure Sufficient Air Flow

Ensure that nothing obstructs the KISS 1U Short V3 from sucking air at the front and exhausting air at the rear.

---

To install in a desktop environment, proceed as follows:

1. Add the rubber feet as described in Chapter 8.1: Attaching the Rubber Feet.
2. Remove the handle brackets as described in Chapter 8.2: Removing the Handle Brackets
3. If required, remove the front access panel and the two front access panel side-plates as described in Chapter 8.3: Removing the Front Access Panel and Front Access Panel Side-Plates.

## 8.5. Installation in a 19" Industrial Rack

The KISS 1U Short V3 is designed for horizontal installation in a 19" industrial rack cabinet with the top cover facing upwards. There are no ventilation holes on the top and bottom side of the product, enabling installation directly on top of or below other systems in the 19" industrial rack cabinet.

Before installing or removing the KISS 1U Short V3 in a 19" industrial rack, observe the instructions described in this chapter and any additional safety warnings.. To assemble for 19" rackmount installation, see Chapter 8.6: Installing Slide Rails (Option).

### **⚠ WARNING**

Install only in a stable 19" industrial rack cabinet. To improve stability:

- ▶ Install systems from the bottom up
- ▶ Place heavy systems lower down
- ▶ Bolt the cabinet to the floor or anchor the cabinet to the wall

### **⚠ WARNING**

To support the KISS 1U Short V3's weight, two separate fixation methods must be used:

- ▶ Front handle brackets (left side and right side)
- ▶ Slide rails or L brackets or a 19" rack rear side fixation

### **⚠ WARNING**

Ensure Sufficient Air Flow

Ensure that the 19" industrial rack cabinet is well ventilated and does not prevent the KISS 1U Short V3 from sucking air at the front and exhausting air at the rear.

### **⚠ CAUTION**

Installing the KISS 1U Short V3 alone can result in product damage or personal injury.

### **⚠ CAUTION**

Verify secure mounting

Mount using the slides rails on the left and right sides and ensure the front handle brackets are fastened to the left and right sides of the 19" Industrial rack cabinet..



Due to possible access restrictions, before installing the KISS 1U Short V3 install all expansion card and connect required peripherals to the corresponding system ports.

To install in a 19" industrial rack, proceed as follows:

1. Install the slide rails to the KISS 1U Short V3 as described in Chapter 8.6: Installing Slide Rails (Option) (Steps 1-3).
2. Install the corresponding slide kits to the 19" industrial rack cabinet, see Chapter 9.6: Installing Slide Rails (Option) (step 4).
3. Push the KISS 1U Short V3 with slide rail assembly as far as possible into the corresponding rack slide rail.
4. Firmly attach the handle brackets to the side of the 19" industrial rack.
5. Verify that the KISS 1U Short V3 is securely mounted.

## 8.6. Installing Slide Rails (Option)

Kontron offers compatible Slide Rails and Rack Slide Rails Kit for the KISS 1U Short V3. For more information, see Table 2: Accessories and Spares parts.

### ⚠️ WARNING

To support the KISS 1U Short V3's weight two separate fixation methods must be used:

- ▶ Front handle brackets (right side and left side)
- ▶ Slide rails or L brackets or a 19" rack rear side fixation

### ⚠️ CAUTION

Use only the specified screws only to attach telescope slide rails to the KISS 1U Short V3.

### ⚠️ CAUTION

Verify secure mounting

Mount using the slides rails on the left and right sides and ensure the front handle brackets are fastened to the left and right sides of the 19" Industrial rack cabinet.

To install slide rails, proceed as follows:

1. Extend the slide rail to the pulled-out position to expose the inner part of the slide rail (Figure 27) with the four screw holes (Figure 27, Pos. 2).
2. Using the supplied screws (2x (4x M4)) firmly attach the side rail to the left side and right side.
3. Push the slide rail into the pushed-in position (Figure 29).
4. Install the corresponding rack slide rail kits to the 19" industrial rack cabinet, see Figure 30: Assembling the slide rails in an industrial rack cabinet.

Figure 27: Attaching slide rail inner part to KISS 1U Short V3 chassis

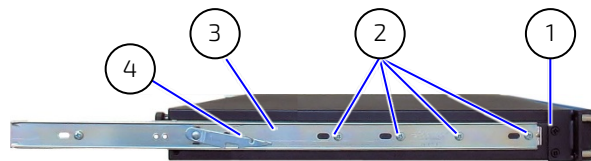

Figure 28: KISS 1U Short V3 with slide rail in pulled-out position

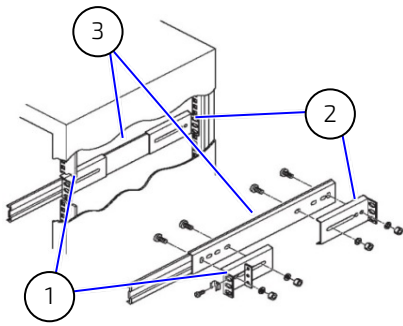

Figure 29: KISS 1U Short V3 with slide rail in pushed-in position



- |  |                                      |
|--|--------------------------------------|
| 1. Side view of the KISS 1U Short V3         | 4. Locking/unlocking lever           |
| 2. 4x M4 rounded head screws (per each side) | 5. Slide rail in pulled-out position |
| 3. Inner part of the slide rail              | 6. Slide rail in pushed-in position  |

Figure 30: Assembling the slide rails in an industrial rack cabinet



1. Short front bracket
2. Long rear bracket
3. Telescopic slide rail attached to Industrial rack cabinet



---

Short brackets are usually used at the front of the chassis and long brackets at the rear.

---

## 9/ Starting Up

Before starting up observe the instructions in Chapter 1: General Safety Instruction for IT Equipment and read the instructions and warnings in this chapter.

### **⚠ WARNING**

#### Easy Access to AC Power Cable and Power Connectors

The power cable must always remain easily accessible. If the end environment restricts access to power cable, disconnection must be guaranteed using a separate cut-off fixture.

### **⚠ WARNING**

#### Energy hazards-240 VA present in the chassis

To switch off the product properly and ensure no energized internal parts, switch off the product using the power switch on the front side and disconnecting the product's power cable from the input power socket or the mains power supply.

### **⚠ WARNING**

#### Intended used is closed

Use only when the cover is closed using the kurnled screws (one front side and three rear side) to ensured that the operator doesn't have access to energized internal parts.

### **⚠ CAUTION**

Ensure that the mains power supply socket (power outlet) is properly grounded and the power cable is in perfect condition with no visible damage.

### **⚠ CAUTION**

The rated mains voltage range must agree with the voltage specified on the type label.

### 9.1. Connecting the Power Connection

The input power socket is located at the rear side. To connect the power and start up, proceed as follows:

1. Connect the ends of the supplied AC power cable to the corresponding sockets:
  - a. Input power socket (Figure 31).
  - b. Mains power supply socket using the electrical plug for the region.

Figure 31: Input power socket



Input power socket

2. Unlock the front access panel (Figure 7, pos. 3) and press the power button (Figure 9, pos. 6).
3. Close and lock the front access panel.
4. The power LED illuminates green (Figure 11, pos. 1).

### **NOTICE**

Do not disconnect the power from the product while the product is powered up!  
Performing a forced shut down can lead to loss of data or other undesirable effects!



## 9.2. Operating System and Hardware Component Drivers

The standard KISS 1U Short V3 is fully operational when switched on for the first time with pre-installed OS (Windows 10 IOT 64-bit or Linux) and drivers. Drivers are available from Kontron's EMD customer section.

If ordered without pre-installed OS, before starting the KISS 1U Short V3 the OS and the appropriate drivers need to be installed for the ordered system configuration. Consider the manufacturer's specifications for the OS and the integrated hardware components.



---

Download relevant drivers for the installed hardware by visiting Kontron's EMD Customer Section at <https://www.kontron.com/support-and-services/support/customer-section>.

Pay attention to the manufacturer specification for OS and installed hardware components.

---

## 10/ Maintenance and Prevention

Kontron systems only require minimal maintenance and care to maintain correct operation.

- ▶ Wipe the product with a soft dry cloth if required
- ▶ Remove persistent dirt using a soft, slightly damp cloth (only use a mild detergent).
- ▶ Clean the air filter pad regularly (as often as necessary, depending on the environment)

### 10.1. Cleaning the Filter Pad

The filter pad inserts into the filter pad holder at the front side of the chassis (Figure 32, pos. 3). The filter pad is soiled by pollution within the operating environment. If heavily soiled the filter pad can cause excessive heating of the device. Kontron recommends cleaning the filter pad as often as necessary (when soiled). The filter pad can be changed during operation.

Figure 32: Front side with filter pad holder and filter pad

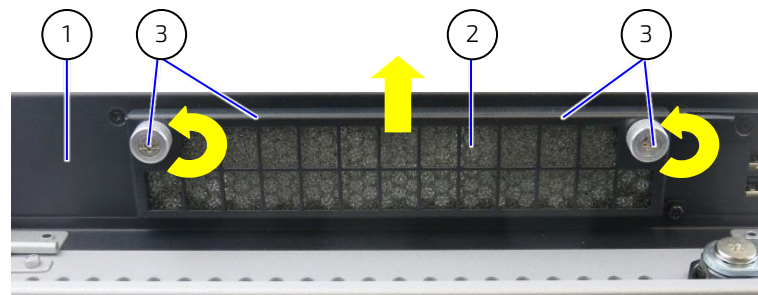

Figure 33: Front side without Filter pad holder

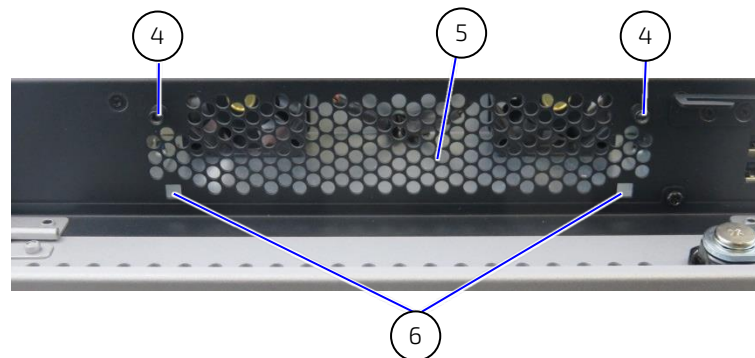

Figure 34: Filter pad holder (without filter pad)

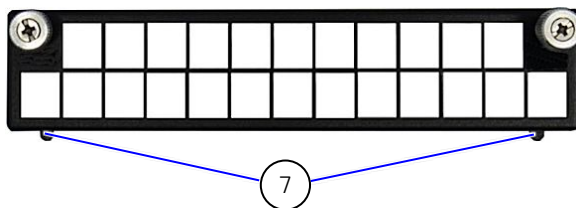
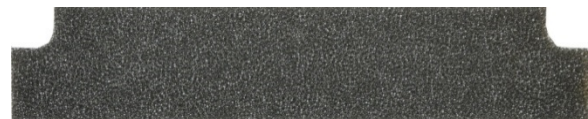

Figure 35: Filter pad



- |   |   |
|---|---|
| <ul style="list-style-type: none"> <li>1. Front side of the KISS 1U Short V2</li> <li>2. Filter pad</li> <li>3. Filter pad holder with knurled screws</li> <li>4. Tapped hole for knurled screws</li> </ul> | <ul style="list-style-type: none"> <li>5. Air intake openings</li> <li>6. Positioning holes for the filter pad holder</li> <li>7. Positioning latch of the filter pad holder</li> </ul> |
|---|---|

**⚠ CAUTION**

Operation is permitted only with a functional fan assembly!  
 Replace a defective fan assemble only with an original fan assembly.

To replace the filter pad, proceed as follows:

1. Open the front access panel.
2. Loosen the knurled screws (Figure 32, pos. 3) that secure the filter pad holder to the chassis in the direction shown.
3. Pull the filter pad holder out from the positioning holes (Figure 33, pos. 6) in the direction marked with the arrow (Figure 32) and lift it out
4. Remove the dirty filter pad.(Figure 35)
5. Clean the filter pad as follows:
  - a. Rinse the filter pad in water (up to approx. 40°C/104°F; with a mild commercial detergent).
  - b. It is also possible to beat the filter pad, suction clean the filter pad or blast the filter pad with warm compressed air.
  - c. If the filter pad is soiled with grease and dust, rinse the filter pad in warm water with a degreaser.
  - d. Do not clean the filter pad with a piercing jet of water or wring it out.
6. Do not wring out the filter pad, allow the filter pad to air dry.
7. After cleaning and drying the filter pad, place the filter pad in the filter pad holder.
8. Reattach the filter pad holder to the front side of the chassis by inserting the positioning latches (Figure 34, pos. 7) into the positioning holes (Figure 33, pos. 6).
9. Fasten the filter pad holder by tightening the knurled screws (Figure 32, pos. 3) to the bolts with tapped holes (Figure 33, pos. 4) on the chassis.

## 10.2. Replacing the System Fans

Before replacing the fan assembly, read the following instructions:

**⚠ WARNING**

Fan assembly NOT replaceable during operation

The KISS 1U Short V3 must be switch off and disconnected from the power source by removing the power cable before replacing the fan assemble. Replace fan only by qualified specialist or a suitably instructed persons aware of the associated dangers. Before removing the fan assembly, wait until the fans have totally stopped and keep hands and fingers away from rotating fan parts.

**⚠ CAUTION**

Operation is permitted only with a functional fan assembly!  
 Replace a defective fan assemble only with an original fan assembly.

To replace the fan assembly proceed as follows:

1. Open the cover as described in Chapter 7.1: Opening and Closing the Cover (steps 1 to 4).
2. Remove the fan assembly by disconnecting power and control cables from the mainboard connectors. (Figure 36, pos. 4)

Figure 36: Fan assembly with power and control cables

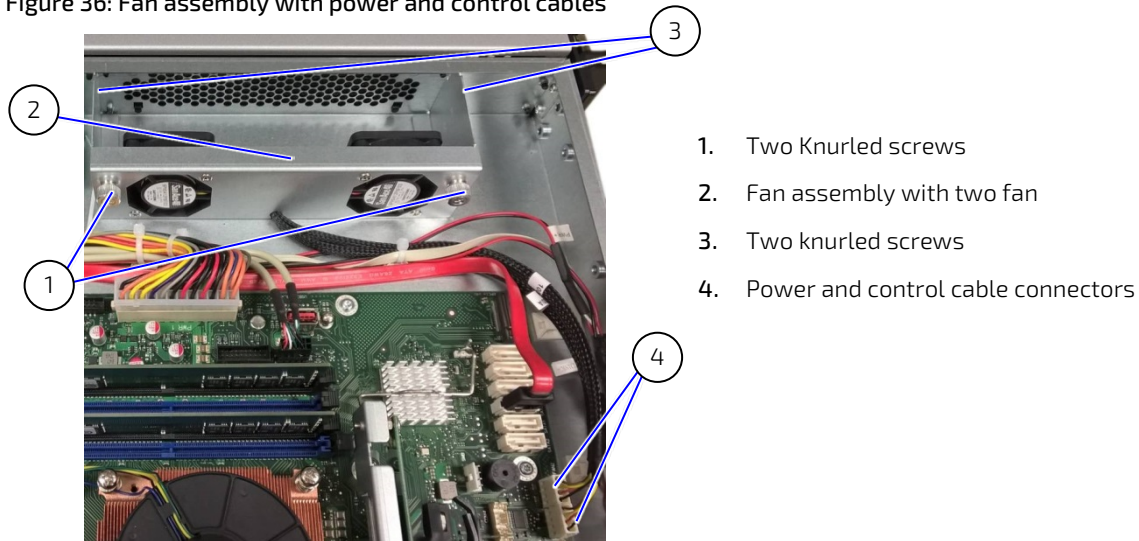

1. Two Knurled screws
2. Fan assembly with two fan
3. Two knurled screws
4. Power and control cable connectors

3. Loosen the two knurled screws on the fan assembly (Figure 36, pos. 1) to release the fan assembly (Figure 36, pos. 2) from the two side plate (Figure 36, pos. 3).
4. Replace with a new fan assembly by securing the fan assembly with the two knurled screws and connecting the power and control cables.
5. Close the cover as described in Chapter 7.1: Opening and Closing the Cover (steps 5)

### 10.3. Replacing the Lithium Battery

#### **CAUTION**

**CAUTION:** Risk of Explosion if the lithium battery is replaced by an incorrect type. Dispose of used lithium batteries according to the Instructions.

**ATTENTION:** Risque d'explosion si la pile au lithium est remplacée par une pile de type incorrect. Éliminez les piles au lithium usagées conformément aux instructions.



Do not dispose of lithium batteries in general trash collection. Dispose of the battery according to the local regulations dealing with the disposal of these special materials, (e.g. collecting points for dispose of batteries).

To replace the lithium battery on the mainboard, proceed as follows:

1. Open the cover, as described in the Chapter 7.1: Opening and Closing the Cover (steps 1-4).
2. If the product includes expansion cards, first remove the expansion cards and all corresponding connecting cables, to gain access to the lithium battery, see Chapter 7.2: Accessing Internal Components.
3. Remove the lithium battery from the holder by pulling the ejector spring outwards.
4. Place a new lithium battery in the battery holder.
5. Pay attention to the polarity of the battery.
6. Replaced the lithium battery only with the same type pf battery, or a type of battery recommended by Kontron.
7. Reinstall the removed expansion cards and reattach the connecting cables.
8. Close the device, as described in the Chapter 7.1: Opening and Closing the Cover (step 5).

# 11/Technical Data

This chapter lists the main KISS 1U Short V3 technical specifications.

## 11.1. Block Diagram

Figure 37: Block diagram KISS 1U Short V3 CFL

### KISS 1U Short V3 CFL

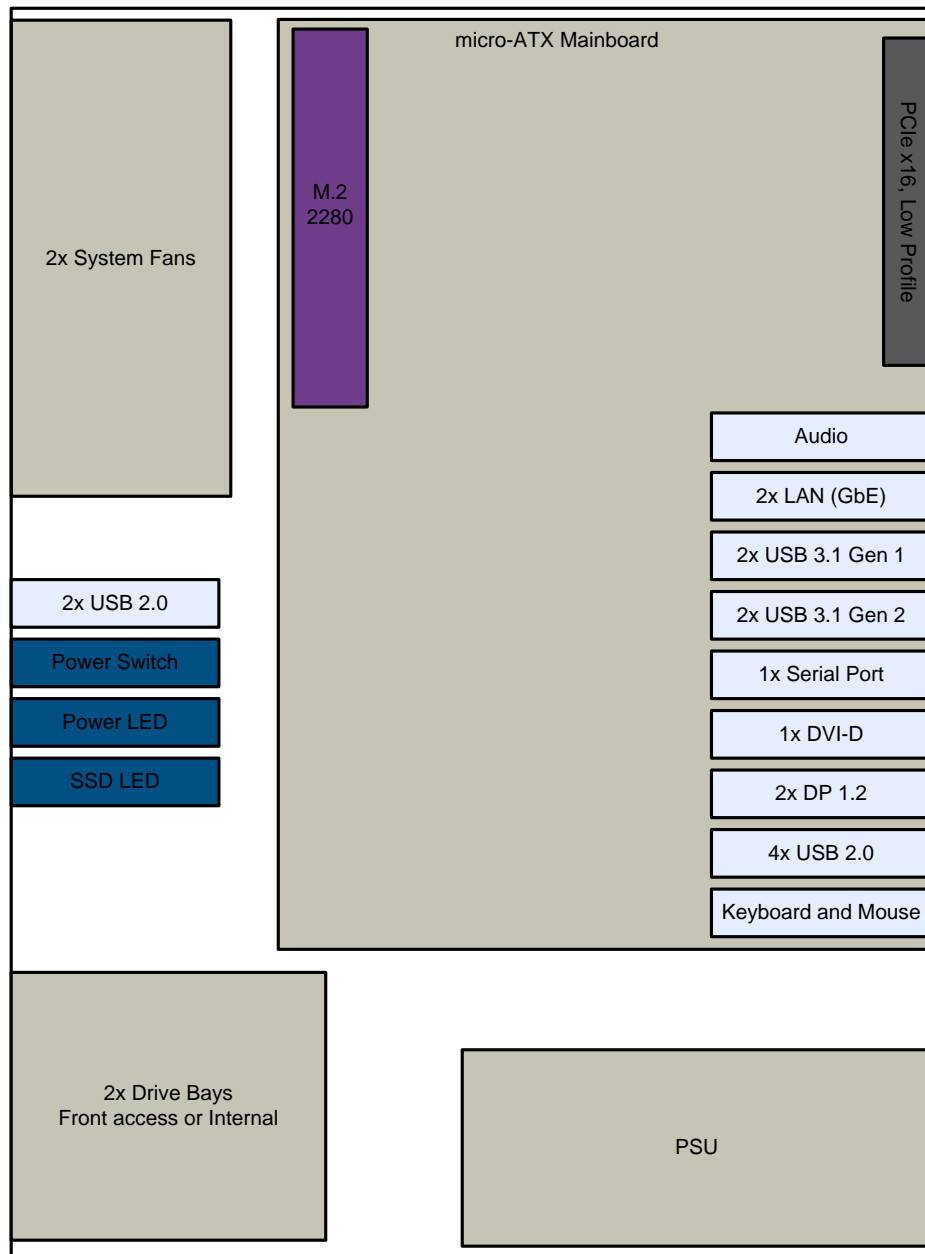

Legend	System	External Controls/ LEDs	Internal Components	External Connectors	External PCIe Slot	On-board slot
	2x System Fans	Power Switch, Power LED, SSD LED	micro-ATX Mainboard, 2x Drive Bays, PSU	2x USB 2.0, 2x USB 3.1 Gen 1, 2x USB 3.1 Gen 2, 1x Serial Port, 1x DVI-D, 2x DP 1.2, 4x USB 2.0, Keyboard and Mouse	PCIe x16, Low Profile	M.2 2280

## 11.2. Technical Specification

KISS 1U Short V3 CFL	
<b>Board</b>	
Mainboard	D3641-S (micro-ATX)
Processor Type	Intel® Core™ i7, i5, i3 series, 8 <sup>th</sup> / 9 <sup>th</sup> generation
Chipset	Intel® C246 Express
Memory	4x DDR4 UDIMM Max. 64 GB (With 2x 4 GB, 2x 8 GB, 2x 16 GB, 4 x 16 GB)
<b>Front I/O</b>	
USB	2x USB 2.0
<b>Drive bays</b>	
Front Accessible	1x slim drive bay for slim DVD drives <b>OR</b> 1x 3.5" drive bay for up to 3x 2.5" drives
Internal	1x 2.5" internal drive bay
<b>Mass Storage</b>	
Mass Storage Device	1x M.2 2280 (PCIe interface)
<b>Rear I/O</b>	
USB	4x USB 2.0 2x USB 3.1 Gen1 2x USB 3.1 Gen2
LAN	2x 1 Gb ▶ 1x i219LM ▶ 1x i210AT
Display	1x DVI-D (1920 x 1200 @60 Hz) 2x Display Port Version 1.2 (4096x2304 @60Hz)
PS/2	Keyboard, Mouse
Audio	1x Line in, 1x Line out, 1x Microphone
Serial Port	1x RS23
<b>Expansion Slots</b>	
Slots	1x PCIe x16 slot (low profile)
<b>Fans</b>	
Internal fans	2x System fans 1x PSU (integrated in PSU) 1x CPU (heatsink with fan)
<b>Software</b>	
Operating System	MS Windows 10 IoT x64 Linux
BIOS	AMI UEFI BIOS 5.x <sup>[1]</sup>

<sup>[1]</sup> Only UEFI BIOS is supported.



---

**UEFI only! No legacy support and no Master Boot Record (MBR) installation.**

---

### 11.3. Power Specification

KISS 1U Short V3 CFL	
<b>Power</b>	
PSU Type	Industrial AC/DC 1HE
Output Power	400 W
Input Voltage Range	240 VAC to 100 VAC (50Hz to 60 Hz) <sup>[1]</sup>
Input Current	6 A Max.

<sup>[1]</sup>The electrical specification is available on the type label. For more information, see Chapter 3.3: Type Label.



The 400 W PSU is a single PSU. A redundant PSU is not supported.

### 11.4. Mechanical Specification

Dimension	KISS 1U Short V3 (with front panel & handles)	KISS 1U Short V3 (without front panel & handles)
Height (1U)	44 mm (1.73")	44 mm (1.73")
Width	482 mm (19")	430 mm ( 16.93")
Depth	368 mm (14.48")	350 mm (13.78")
Weight	6 kg (approx.)	
Chassis	Chassis: RAL 7021 Front panel: RAL 9022 – standard	



For detailed mechanical dimensions, visit Kontron's EMD Customer Section at <https://www.kontron.com/support-and-services/support/customer-section>.

### 11.5. Environmental Specification

Temperature		Description
Temperature	Operating	0 °C to +50 °C (+50°F to +122 °F)
	Storage & Transit	-20°C to +70°C (-4°F to +158°F)
Relative Humidity	Operating and Storage & Transit	10-93 % @ 40° C, non condensing
Environment		Description
Altitude	Operating	5,000 m (16,405 ft.) Max.
	Storage & Transit	10,000 m (32,810 ft.) Max.
Shock	Operating	15 g, 11 ms, duration
	Storage & Transit	30 g., 11 ms, duration
Vibration	Operating	10 – 150 Hz, 1.0 g, 3 axis
	Storage & Transit	10 – 150 Hz, 2.0 g, 3 axis
MTBF		50,000 h

## 11.6. CE Directives and Standards

The KISS 1U Short V3 complies with the European Council Directive and the approximation of the laws of the member states. If modified, the prerequisites for specific approvals may no longer apply.

Kontron is not responsible for any radio television interference caused by unauthorized modifications of the product or the substitution or attachment of connecting cables and equipment other than those specified by Kontron. The correction of interference caused by such unauthorized modification, substitution or attachment will be the responsibility of the operator.

<b>CE</b>		
CE Marking	Council Directive	93/68/EEC
Safety	General Product Safety Directive (GPSD)	2001/95/EC
	Low Voltage Directive (LVD)	2014/35/EU
Electromagnetic Compatibility	Electromagnetic Compatibility Directive (EMC)	2014/30/EU
<b>EMC</b>		
Emission (Class B)	EN 55032/ CISPR 32	Electromagnetic compatibility of multimedia equipment- Emission requirements
	EN 61000-6-3	Emission standard for residential, commercial and light-industrial environments
Immunity (Industrial Equipment)	EN 55024/ CISPR 24	Information technology equipment- Immunity characteristics
	EN6100-6-2	Immunity for industrial environments
<b>Safety</b>		
Europe	EN 62368-1	Audio/video, information and communication technology equipment – Safety requirements
CB Scheme	CB Report - IEC 62368-1	
<b>Environment</b>		
WEEE	Compliant with the Waste Electrical and Electronic Equipment (WEEE) 2012/19/EU directive; to reduce waste of electrical and electronic equipment, encourage recycling and environmental disposal and increase the environmental awareness of producers	
RoHS II	Compliant with the Restriction of Hazardous Substances (RoHS) 2011/65/EU directive or the late status thereof, to reduce hazardous substances in electrical and electronic equipment	
REACH	Compliant with the Registration, Evaluation, Authorization and Restriction of Chemicals (REACH) Regulation No. 1907/2006 to identify the intrinsic properties of chemical substances earlier	



## 12/ Standard Interfaces- Pin Assignments

### 12.1. Keyboard Connector Pin Assignment

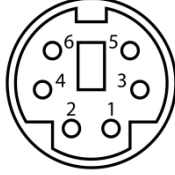
Pin	Signal Name	Keyboard Connector
1	Data	
2	NC	
3	GND	
4	+5V <sup>[1]</sup>	
5	Clock	
6	Keyboard_On <sup>[2]</sup>	

<sup>[1]</sup> fuse protected

<sup>[2]</sup> low asserted pulse

### 12.2. PS/2 Mouse Connector Pin Assignment

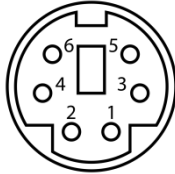
Pin	Signal Name	PS/2 Connector
1	Data	
2	NC	
3	GND	
4	+5V <sup>[1]</sup>	
5	Clock	
6	Keyboard_On <sup>[2]</sup>	

<sup>[1]</sup> fuse protected

<sup>[2]</sup> low asserted pulse

### 12.3. USB 2.0 Port Pin Assignment

Pin	Signal Name	USB 2.0 Port 4-pin (Type A)
1	+5V <sup>[1]</sup>	
2	Data-	
3	Data+	
4	GND	

<sup>[1]</sup> fuse protected

### 12.4. Display Port Pin Assignment

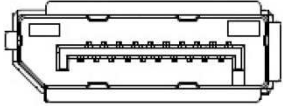
Pin	Signal Name	Pin	Signal Name	DP (V1.2) Connector
1	TX0+	11	GND	
2	GND	12	TX3-	
3	TX0-	13	DVI dongle detect/ GND	
4	TX1+	14	GND / CEC for HDMI	
5	GND	15	AUX+	
6	TX1-	16	GND	
7	TX2+	17	AUX-	
8	GND	18	Hot plug detect	
9	TX2-	19	GND	
10	TX3+	20	+3.3 V <sup>[1]</sup>	

<sup>[1]</sup> (fuse protected)

### 12.5. COM 1 Connector Pin Assignment

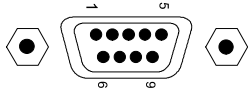
Pin	RS232	RS422	RS 485 Half Duplex	RS 485 Full Duplex	9-pin D-SUB Connector
1	DCD	Tx-	Data-	Tx-	
2	RxD	Tx+	Data+	Tx+	
3	TxD	Rx+		Rx+	
4	DTR	Rx-		Rx-	
5	GND	GND	GND	GND	
6	DSR				
7	RTS				
8	CTS				
9	RI				

### 12.6. DVI-D Connector Pin Assignment

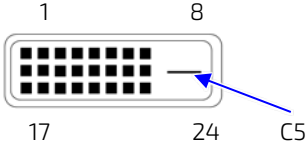
Pin	Signal Name	Pin	Signal Name	Pin	Signal Name	DVI-D Connector
1	Data2-	9	Data1-	17	Data0-	
2	Data2+	10	Data1+	18	Data0+	
3	GND	11	GND	19	GND	
4	NC	12	NC	20	NC	
5	NC	13	NC	21	NC	
6	DDC Clock	14	+5 V <sup>[1]</sup>	22	GND	
7	DDC Data	15	GND	23	Clk +	
8	NC	16	Hot Plug Detect	24	Clk -	

<sup>[1]</sup> fuse protected

Note: DVI-D Dual-link socket supports single-link only.

### 12.7. LAN Connector Pin Assignment

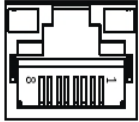
Pin	Signal Name (10/100/1000)	Pin	Signal Name (10/100)	RJ45 (female) Connector
1	MX1+	1	TX+	
2	MX1-	2	TX-	
3	MX2+	3	RX+	
4	MX3+	4	NC	
5	MX3-	5	NC	
6	MX2-	6	RX-	
7	MX4+	7	NC	
8	MX4-	8	NC	

Left LED: Activity / Link		Right LED: Activity 10/100/1000	
Off	NO LAN connectivity	Green	10 Mbit
Yellow	Link	OFF	100 Mbit
Blinking	Activity	Orange	1 GbE

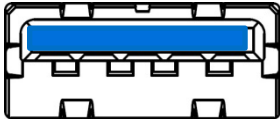
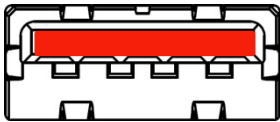

### 12.8. USB 3.1 (Gen 1) Port and USB 3.1 (Gen2) Port Pin Assignment

Pin	Signal Name	Pin	Signal Name	9-pin Type A
1	+5V <sup>(1)</sup>	5	USB3_RX-	 USB 3.1 Gen 1
2	USB2_D-	6	USB3_RX+	
3	USB2_D+	7	GND	 USB 3.1 Gen 2
4	GND	8	USB3_TX-	
		9	USB3_TX+	

<sup>(1)</sup> fuse protected

Note: All USB 3.1 connectors provide separate signal lines for USB 3.1 and USB 2.0.

### 12.9. Audio Jack Pin Assignment

Jack	Signal	Audio Barrel Jack
A	Line-in	
B	Line-out	
C	Microphone-in	

## 13/ Technical Support

In order to request technical support, please send an email with the information below to [support@kontron.com](mailto:support@kontron.com)

- ▶ Product name
- ▶ Product model number
- ▶ Serial number of the unit
- ▶ Brief problem description
- ▶ Complete company address

Customers with service portal access may maintain their tickets directly in the service portal.



---

The serial number can be found on the product's type label.

---

### 13.1. Returning Defective Merchandise

All equipment returned to Kontron must have a Return of Material Authorization (RMA) number assigned exclusively by Kontron. Kontron cannot be held responsible for any loss or damage caused to the equipment received without an RMA number. The buyer accepts responsibility for all freight charges for the return of goods to Kontron's designated facility. Kontron will pay the return freight charges back to the buyer's location in the event that the equipment is repaired or replaced within the stipulated warranty period.

Follow these steps before returning any product to Kontron.

1. Visit the RMA Information website:



---

Kontron's RMA Information website can be found at:

<http://www.kontron.com/support-and-services/support/rma-information>

---

2. Download the RMA Request sheet for Kontron Europe GmbH, Augsburg and fill out the form. Take care to include a short detailed description of the observed problem or failure and to include the product identification (product name, material number and serial-number). If more than one product is sent in a delivery. Fill out the above information in the RMA Request form for each product.
3. Send the completed RMA-sheet to the given fax or email address at Kontron Europe GmbH. Kontron Europe GmbH will provide an RMA-Number within one business day.
4. The goods for repair shall be packed properly for shipping, considering shock and ESD protection.



---

Goods returned to Kontron Europe GmbH in non-proper packaging are considered as customer caused faults and cannot be accepted as warranty repairs.

---

5. Add the RMA-sheet to the relevant delivery address and include the RMA-No with the shipping paperwork.

Sent the product to the following delivery address:

Kontron Europe GmbH  
RMA Support  
Lise-Meitner-Str. 3-5  
86156 Augsburg  
Germany

Phone: +49 (0) 821 4086-0  
Fax: +49 (0) 821 4086 111  
Email: [service@kontron.com](mailto:service@kontron.com)

6. After Kontron Europe GmbH receives the product, a confirmation of the order is sent via email to the address named on the RMA sheet.

## 14/ Storage and Transportation

### 14.1. Storage

If the product is not in use for an extended period time, disconnect the power plug from the mains power source. If it is necessary to store the product then re-pack the product as originally delivered to avoid damage. The storage facility must meet the products environmental storage requirements as stated within this user guide. Kontron recommends keeping the original packaging material for future storage or warranty shipments.

### 14.2. Transportation

To ship the product use the original packaging, designed to withstand impact and adequately protect the product. When packing or unpacking products always take shock and ESD protection into consideration and use an EOS/ESD safe working area.

## 15/ Warranty

Kontron defines product warranty in accordance with regional warranty definitions. Claims are at Kontron's discretion and limited to the defect being of a material nature. To find out more about the warranty conditions and the defined warranty period for your region, following the steps below:

1. Visit Kontron's Term and Conditions webpage.  
<http://www.kontron.com/terms-and-conditions>
2. Click on your region's General Terms and Conditions of Sale.

### 15.1. Limitation/Exemption from Warranty Obligation

In general, Kontron shall not be required to honor the warranty, even during the warranty period, and shall be exempted from the statutory accident liability obligations in the event of damage caused to the product due to failure to observe the following:

- ▶ General safety instructions for IT equipment within this user guide
- ▶ Warning labels on the product and warning symbols within this user guide
- ▶ Information and hints within this user guide

Additionally, alterations or modifications to the product that are not explicitly approved by Kontron, described in this user guide, or received from Kontron Support as a special handling instruction will void your warranty.

Due to their limited service life, parts which by their nature are subject to a particularly high degree of wear (wearing parts) are excluded from the warranty beyond that provided by law.

## 16/ Disposal

Final disposal of this product after the product's service life must be accomplished in accordance with the applicable country, state, or local laws or regulations.



---

**Kontron manufactures products to satisfy environmental protection requirements where possible. Many of the components used are capable of being recycled.**

---

Kontron follows the Waste Electrical and Electronic Equipment (WEEE) Directive that aims to reduce waste arising from Electrical and Electronic waste and therefore encourages customers to return Kontron products for proper disposal. For more information regarding WEEE compliance, refer to the Disposal and Recycling section at the start of this user guide.



## List of Acronyms

Table 6: List of Acronyms

<b>ATX</b>	Advanced Technology eXtended
<b>BIOS</b>	Basic Input Output System
<b>CLI</b>	Command-Line Interface
<b>COM</b>	Communication port
<b>CPU</b>	Central Processing Unit
<b>DC</b>	Direct Current
<b>DDR</b>	Double Data Rate
<b>DIMM</b>	Dual Inline Memory Module
<b>DP</b>	Display port
<b>DVD</b>	Digital Video Device
<b>DVI</b>	Digital Video Interface
<b>ECC</b>	Error Checking and Correction
<b>EMC</b>	Electromagnetic Compatibility
<b>ESD</b>	ElectroStatic Discharge
<b>GbE</b>	Giga bit Ethernet
<b>GPU</b>	Graphics Processing Unit
<b>HD/HDD</b>	Hard Disk /Drive
<b>HPM</b>	PICMG Hardware Platform Management specification family
<b>IOL</b>	IPMI-Over-LAN
<b>IOT</b>	Internet of Things
<b>IPMI</b>	Intelligent Platform Management Interface
<b>KCS</b>	Keyboard Controller Style
<b>KBD</b>	Keyboard
<b>KVM</b>	Keyboard Video Mouse
<b>LAN</b>	Local Area Network
<b>LED</b>	Light-Emitting Diode
<b>MEI</b>	Management Engine Interface
<b>NCSI</b>	Network Communications Services Interface

<b>OS</b>	Operating System
<b>PCB</b>	Plastic Circuit Board
<b>PCI</b>	Peripheral Component Interconnect
<b>PCIe</b>	PCI-Express
<b>PECI</b>	Platform Environment Control Interface
<b>PICMG®</b>	PCI Industrial Computer Manufacturers Group
<b>PSU</b>	Power Supply Unit
<b>RAM</b>	Random Access memory
<b>RDIMM</b>	Registered DIMM
<b>REACH</b>	Registration, Evaluation, Authorization and restriction of Chemicals
<b>RMA</b>	Return of Material Authorization
<b>RTC</b>	Real Time Clock
<b>SBC</b>	Single Board Computer
<b>SEL</b>	System Event Log
<b>ShMC</b>	Shelf Management Controller
<b>SMBus</b>	System Management Bus
<b>SMWI</b>	System Monitor Web Interface
<b>SOL</b>	Serial Over LAN
<b>SRAM</b>	Synchronus Dynamic Random Access Memory
<b>SSD</b>	Solid State Drive
<b>SSH</b>	Secure Shell
<b>TPM</b>	Trusted Platform Module
<b>UDIMM</b>	Unregisterd DIMM
<b>UEFI</b>	Unified Extensible Firmware Interface
<b>USB</b>	Universal Serial Bus
<b>WEEE</b>	Waste Electrical and Electronic Equipment



## About Kontron

Kontron is a global leader in IoT/Embedded Computing Technology (ECT). Kontron offers individual solutions in the areas of Internet of Things (IoT) and Industry 4.0 through a combined portfolio of hardware, software and services. With its standard and customized products based on highly reliable state-of-the-art technologies, Kontron provides secure and innovative applications for a wide variety of industries. As a result, customers benefit from accelerated time-to-market, lower total cost of ownership, extended product lifecycles and the best fully integrated applications.

For more information, please visit: [www.kontron.com](http://www.kontron.com)



## Global Headquarters

### Kontron Europe GmbH

Gutenbergstraße 2  
85737 Ismaning  
Germany  
[www.kontron.com](http://www.kontron.com)